

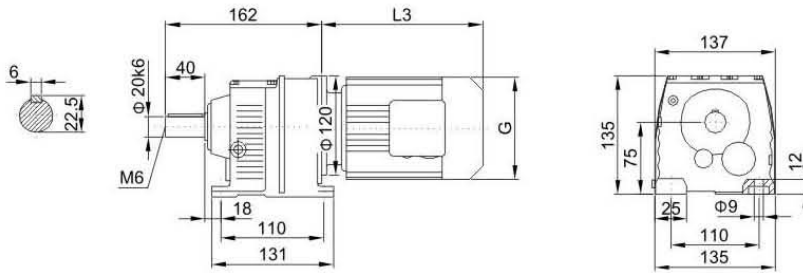

外形安装尺寸 Mounting Dimension Sheets-overview

R17



电机需方配时或配特殊电机时需加联接法兰
When equipping the user's motor or the special one, the flange is required to be connected.

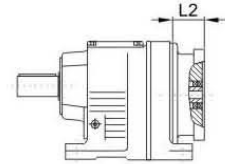

RF17

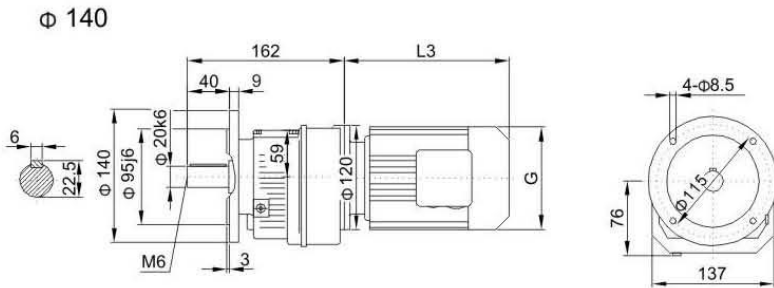
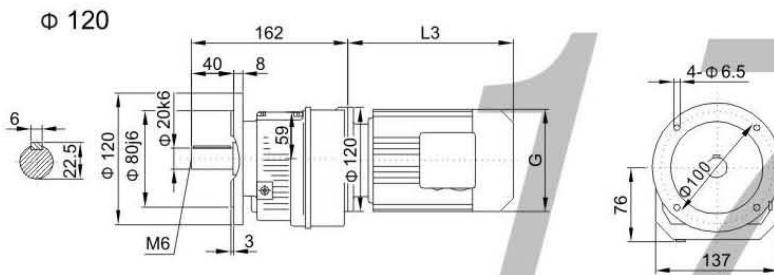

注：其余尺寸见相应的结构形式
Note: For other values please refer to the opposite structure

R

Y ₂ 电机机座号 Motor size	63	71	80						
功率/4P Power/(kW)	0.18	0.25 0.37	0.55 0.75						
L3	235	245	278						
G	130	145	175						
L2	71	71	71						

注：“R..”表示R、RF
Note：“R..”mean R、RF



R27

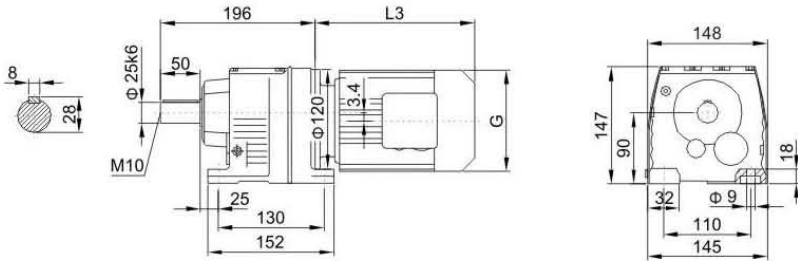

电机需方配时或配特殊电机时需加联接法兰
When equipping the user's motor or the special one, the flange is required to be connected.

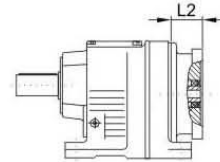

RF27

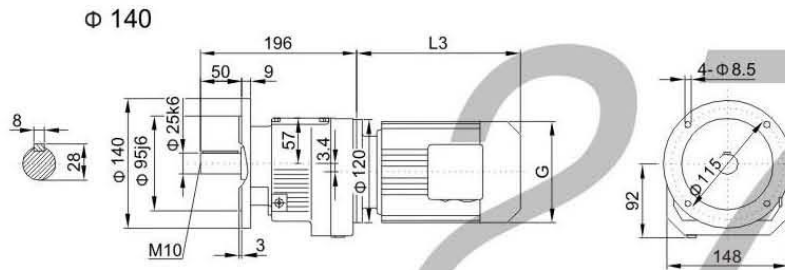

R..S27

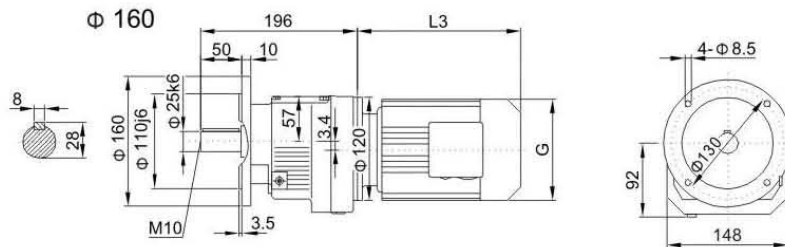
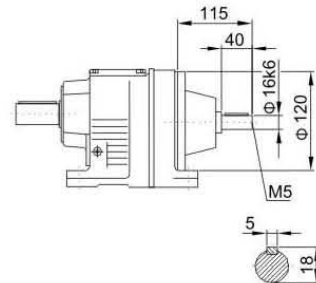

R..27R17

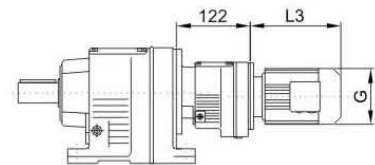

注：其余尺寸见相应的结构形式
Note: For other values please refer to the opposite structure

R

Y ₂ 电机座号 Motor size	63	71	80	90S	90L	100	
功率/4P Power/(kW)	0.18	0.25 0.37	0.55 0.75	1.1	1.5	2.2 3.0	
L3	235	245	278	304	328	340	
G	130	145	175	195	195	215	
L2	71	71	71	71	71	93	

注：“R..”表示R、RF Note：“R..”mean R、RF



外形安装尺寸 Mounting Dimension Sheets-overview

R37

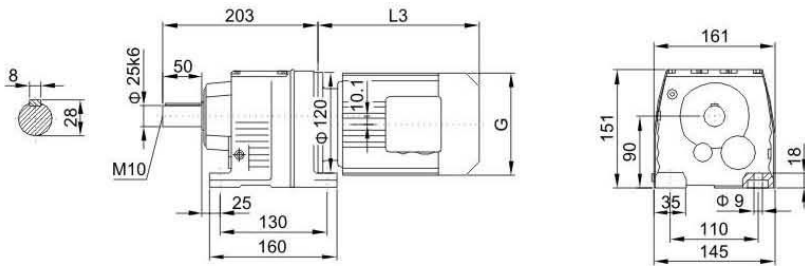

电机需方配时或配特殊电机时需加联接法兰
When equipping the user's motor or the special one, the flange is required to be connected.

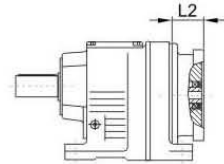

RF37

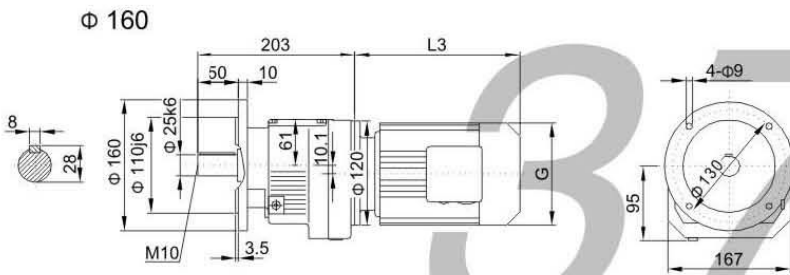

R..S37

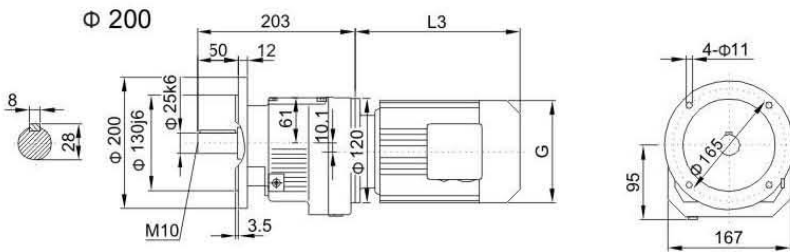
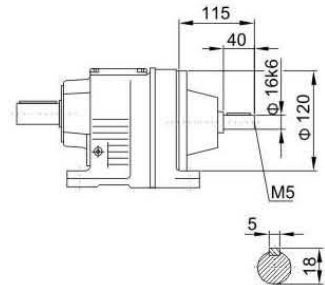

R..37R17

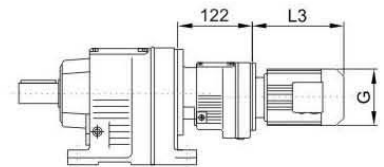

注：其余尺寸见相应的结构形式
Note: For other values please refer to the opposite structure

Y ₂ 电机机座号 Motor size	63	71		80		90S	90L	100L	
功率/4P Power/(kW)	0.18	0.25	0.37	0.55	0.75	1.1	1.5	2.2	3.0
L3	235	245		278		304	328	340	
G	130	145		175		195	195	215	
L2	71	71		71		71	71	93	

注：“R..”表示R、RF

Note：“R..”mean R、RF



R47

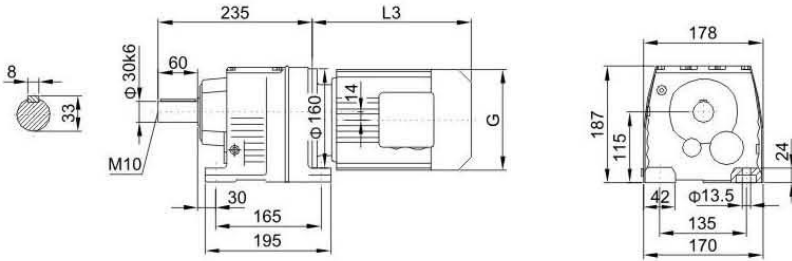

电机需方配时或配特殊电机时需加联接法兰
When equipping the user's motor or the special one, the flange is required to be connected.

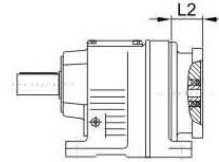

RF47

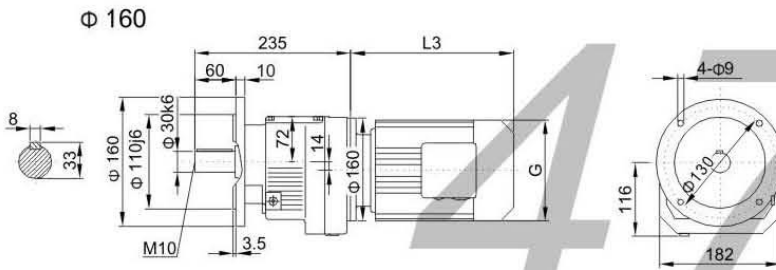

R..S47

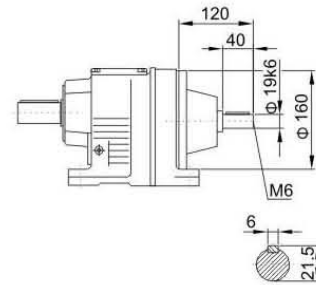

R..47R37

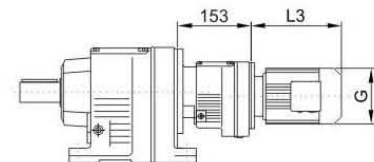

注：其余尺寸见相应的结构形式
Note: For other values please refer to the opposite structure

R

Y ₂ 电机机座号 Motor size	63	71	80	90S	90L	100	112M	132S	
功率/4P Power/(kW)	0.18	0.25 0.37	0.55 0.75	1.1	1.5	2.2 3.0	4.0	5.5	
L3	223	245	278	304	328	350	380	425	
G	130	145	175	195	195	215	240	275	
L2	81	81	81	81	81	93	93	101	

注：“R..”表示R、RF

Note：“R..”mean R、RF



外形安装尺寸 Mounting Dimension Sheets-overview

R57

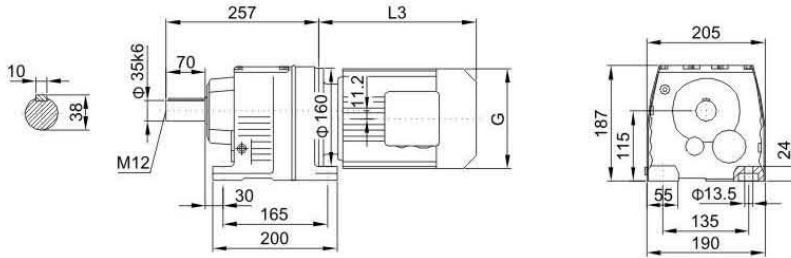

电机需方配时或配特殊电机时需加联接法兰
When equipping the user's motor or the special one, the flange is required to be connected.

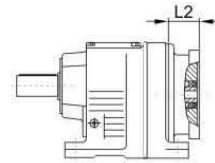

RF57

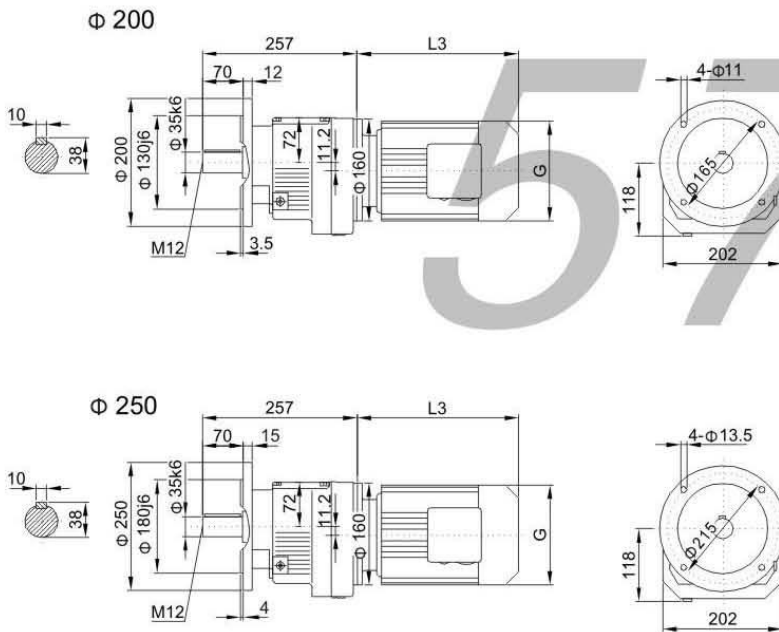

R..S57

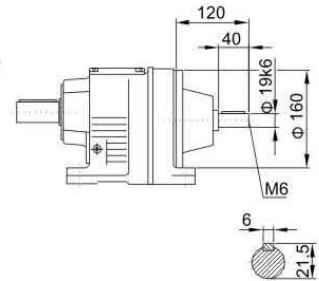

R..57R37

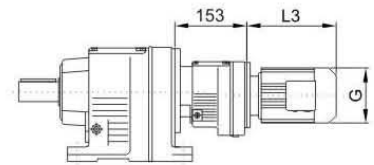

注：其余尺寸见相应的结构形式
Note: For other values please refer to the opposite structure

Y ₂ 电机机座号 Motor size	63	71	80	90S	90L	100L	112M	132S	132M	
功率/4P Power/(kW)	0.18	0.25 0.37	0.55 0.75	1.1	1.5	2.2 3.0	4.0	5.5	7.5	
L3	223	245	278	304	328	350	380	425	461	
G	130	145	175	195	195	215	240	275	275	
L2	81	81	81	81	81	93	93	101	101	

注：“R..”表示R、RF

Note:“R..”mean R、RF



R67

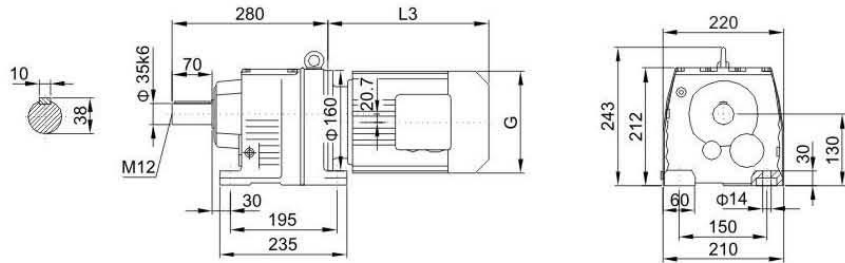

电机需方配时或配特殊电机时需加联接法兰
When equipping the user's motor or the special one, the flange is required to be connected.

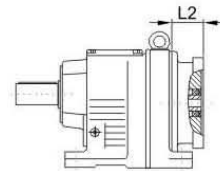

RF67

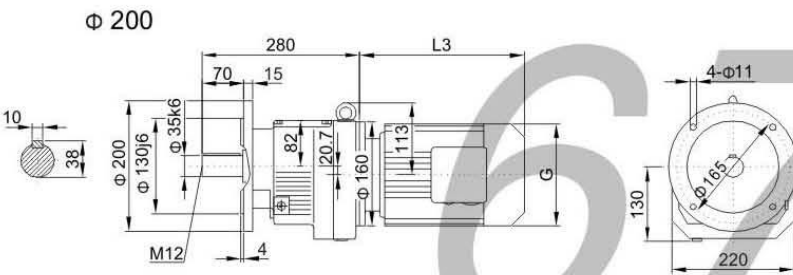

R..S67

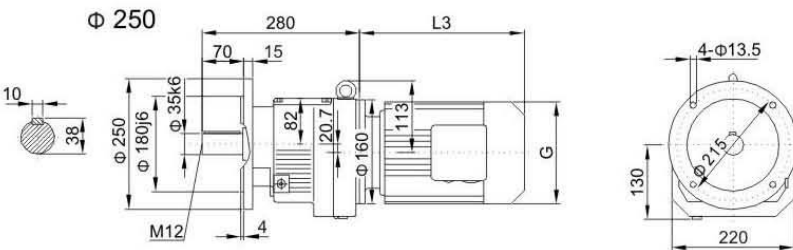
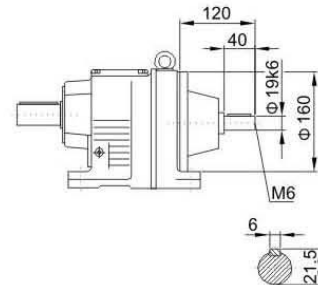

R..67R37

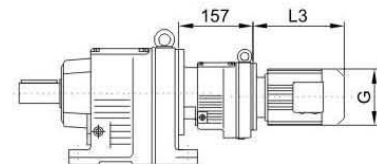

注：其余尺寸见相应的结构形式
Note: For other values please refer to the opposite structure

Y ₂ 电机机座号 Motor size	63	71	80	90S	90L	100L	112M	132S	132M	
功率/4P Power/(kW)	0.18	0.25 0.37	0.55 0.75	1.1	1.5	2.2 3.0	4.0	5.5	7.5	
L3	223	245	278	304	328	350	380	425	461	
G	130	145	175	195	195	215	240	275	275	
L2	81	81	81	81	81	93	93	101	101	

注：“R..”表示R、RF

Note：“R..”mean R、RF

R